

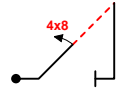

Pilot ID	Yak 52 Known									Flight #
----------	---------------------	--	--	--	--	--	--	--	--	----------

No	Symbol	Cat. No.	K	Total K	Example marks:		Remarks	Pos	Item	K	Grade			
					[7][5]	[0][0]								
					Zeros and Averages:									
					[H][Z]	[P][Z]	[A][V]							
1		1.1.1.1 9.1.3.8	2 12	14					Positioning					
2		1.2.3.1 9.8.2.2	12 9	21					Fig K		Total K			
										172	172			
												Penalties		
												Too Low		
												Disqual Fig		
												Too High		
												Outs		
												Interruptions		
												Insertions		
												Missed Slot		
												Trg Violation		
												Faulty Wing Rocks		
												Final Freestyle		
										Duration	Min	Sec		
												Judges Details		
												Signature		
												Name		
												Number		
3		8.6.5.1 9.1.3.4	11 8	19										
4		5.2.1.1 9.1.1.3	17 10	27										
5		1.1.6.1 9.1.1.1	10 6	16										
6		1.1.6.3 9.11.1.4	10 5	15										
7		1.1.2.1 9.9.2.4	7 13	20										
8		2.2.5.1	22	22										
9		1.1.1.1 9.9.3.2 9.4.3.2	2 11 5	18										

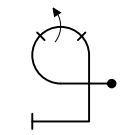
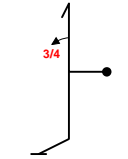
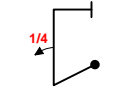
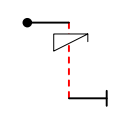
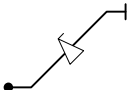
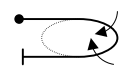

Pilot ID #

Yak 52 Known

Flight #

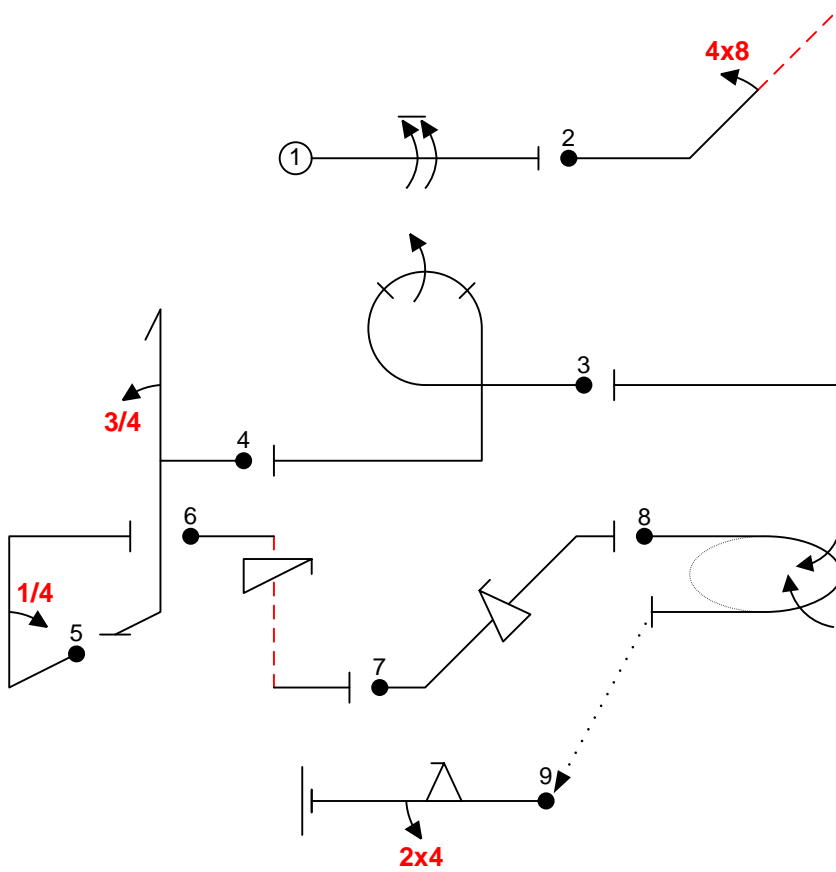
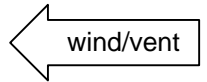

Fig 1	1.1.1.1 9.1.3.8	2 12	14
Fig 2	1.2.3.1 9.8.2.2	12 9	21
Fig 3	8.6.5.1 9.1.3.4	11 8	19
Fig 4	5.2.1.1 9.1.1.3	17 10	27
Fig 5	1.1.6.1 9.1.1.1	10 6	16
Fig 6	1.1.6.3 9.11.1.4	10 5	15
Fig 7	1.1.2.1 9.9.2.4	7 13	20
Fig 8	2.2.5.1	22	22
Fig 9	1.1.1.1 9.9.3.2 9.4.3.2	2 11 5	18
Total K = 172			



2013

FORM C

Pilot ID #

Yak 52 Known

Flight #

